

LEGGE G2 Series

Legge products have an outstanding reputation for quality, performance and functionality and the new G2 cylindrical lockset is no exception. The G2 lockset offers Grade 2 ANSI Certification which makes it suitable for both residential and light commercial applications e.g: apartments, offices and factories.

Standard G2 Series functions include entrance, passage, privacy, patio and dummy trim. Commercial functions such as classroom, storeroom, and Vanguard options are also available for added security and life safety.



Pictured: G2 Neptune lever

Performance Features

- Tested in excess of 400,000 operating cycles.
- Key removable outside lever for quick and easy cylinder replacement.
- Snap-on inside rose conceals mounting plate and screws.
- Supplied standard with D and T strikes and spacer rings.
- 6 Pin tumbler with two nickel silver keys per lock supplied with both Schlage 6 Pin 'C' keyway and C4 6 pin keyway as standard.
- The G2-Series is ideally suited for residential, light and medium duty commercial applications.
- Non handed.
- Fire Rating: Refer to Appendix.

Specification Guide

G2 Series	N Lever	ENT Function	SCP Finish
G2	Neptune..... N Orbit O	G10S Passage..... PAS G30D Patio PAT G40S Privacy..... PRI G50PD Entrance ENT G66PD Double Cylinder Lock..... DCENT G70PD Classroom CLA G80PD Store Room..... STR G170 Dummy Trim..... DUM G91PD Vanguard Entrance..... VENT G96PD Vanguard Store Room..... VSTR	Satin Chrome Plate..... SCP

Note: Orbit knob only available in G50PD and G80PD Functions

- Series
Select the desired series
e.g. G2 G2
- Lever
Select the required lever
e.g. Neptune G2N
- Function
Select the required function
e.g. G50PD Entrance G2NENT
- Finish
Select the desired finish
e.g. Satin Chrome Plate G2NENTSCP



G2 Series

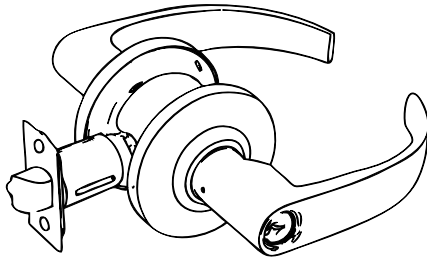

Pictured: G2 Neptune lever

Specifications	
Door Type	Timber or Metal
Door Thickness	35mm to 50mm
Chassis	Steel, Zinc Dichromate Plated
Lever	Pressure Cast Zinc – Plated finish
Knob	Wrought Brass – Plated finish
Outer Forend	Stainless Steel
Bolt	Stainless Steel
Strike Plate	Stainless Steel 45mm standard 22mm optional
Backsets	70mm Standard, 60mm and 127mm backset latches available
Key Cylinder	Brass Schlage C 6 pin keyway and C 4 pin keyway standard. Schlage E 6 pin keyway is optional
Finishes	Satin Chrome Plate
Warranty	7 Years

Neptune Dimensions

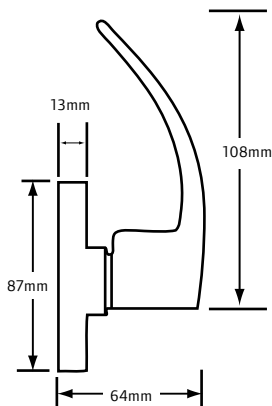

Orbit Dimensions

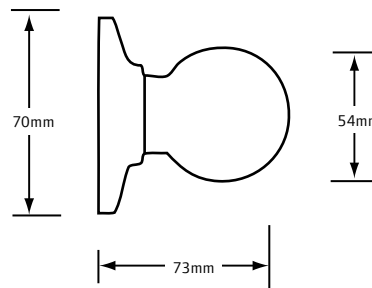



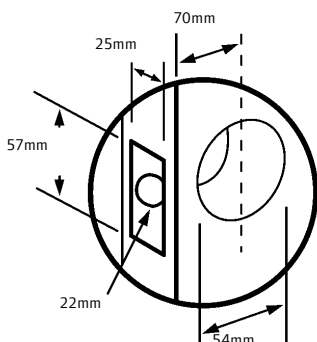





Door Preparation











LEGGE G2 Series

Functions

Non-Keyed

Functions	Description	Inside	Outside
Passage Latch G10S	Both levers always unlocked.		
Patio Lock G30D	Push-button locking. Turning inside lever or closing door releases button, preventing lock-out.		
Bath/Bedroom Privacy Lock G40S	Push-button locking locks outside lever. Turning inside lever releases button. Outside lever has emergency release.		
G170 Single Dummy Trim	Dummy trim for one side of door. Used for door pull or as matching inactive trim.		

Keyed

Functions	Description	Inside	Outside
Entrance Lock G50PD	Turn/push-button locking: pushing and turning button locks outside lever requiring use of key until button is manually unlocked. Push-button locking: pushing button locks outside lever until unlocked by key or by turning inside lever.		
Double Cylinder Entrance Lock G66PD	Key outside locks/unlocks both handles simultaneously. Key inside locks/unlocks both handles simultaneously.		
Classroom Lock G70PD	Outside lever locked and unlocked by key. Inside lever always unlocked.		
Storeroom Lock G80PD	Outside lever fixed. Entrance by key only. Inside lever always unlocked.		



G2 Series

Accessories

Springlatch

Backset: 60mm, 70mm & 127mm.

Faceplate Dimensions: 25mm X 57mm.

Housing Diameter: 22mm.

Bolt Throw: 13mm.

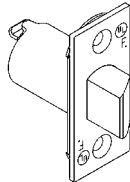

D Strike

Dimensions: H59mm X W47mm.

Finish: Satin Stainless Steel.

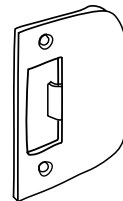

Deadlatch

Backset: 60mm, 70mm & 127mm.

Faceplate Dimensions: 25mm X 57mm.

Housing Diameter: 22mm.

Bolt Throw: 13mm.

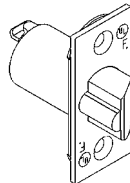

T Strike

Dimensions: H70mm X W29mm. Including lip W45mm.

Finish: Satin Stainless Steel.

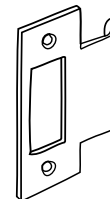

Rebate Kit

This kit adapts latches and strikes for 13mm rebated door and frame preparations.

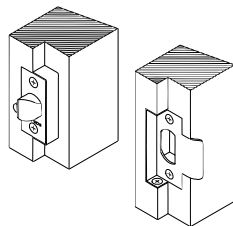

Packing Ring

Outside diameter: 82mm.

Inside diameter: 54mm.

Finish: Satin Stainless Steel.

